

PROFIL D'ANGLE ET SUPPORT CENTRAL

CAPOT

FAITAGE

Réf 7053

Réf 671

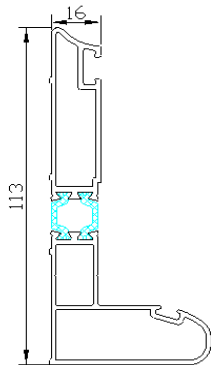

Réf 7050TH

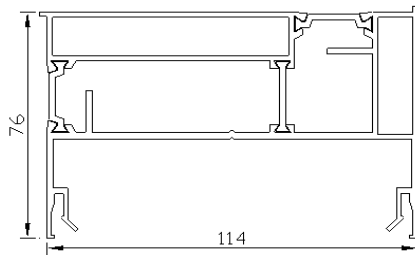

Réf 7018TH

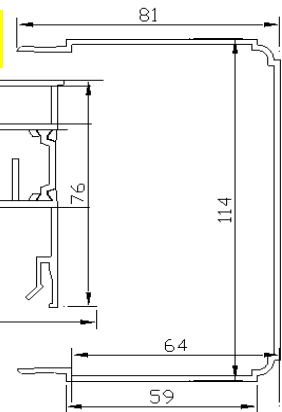
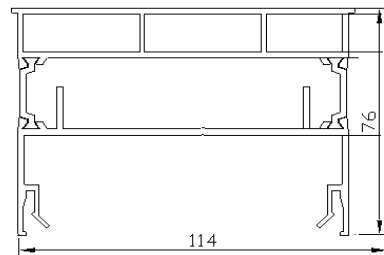

NEZ DE PLAQUE

Réf 7058



Réf 593

Epaisseur 16 mm

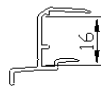

Réf 596

Epaisseur 25mm



Réf 595

Epaisseur 32mm

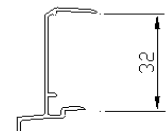

CHEVRON

(Remplissage 16 ou 32 mm)

PROFIL DE RIVE

Réf 607

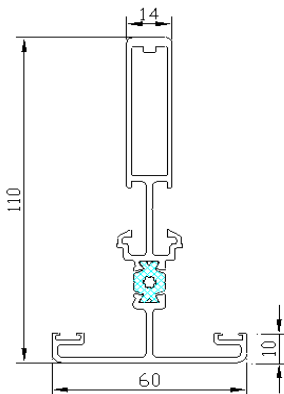

Réf 602

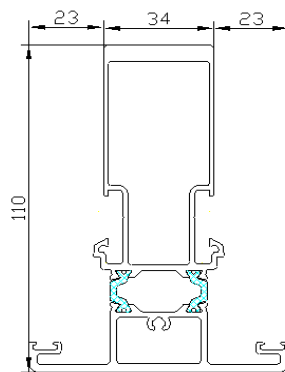

Réf 614

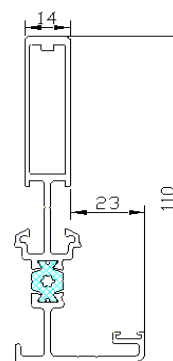

Réf 687+614

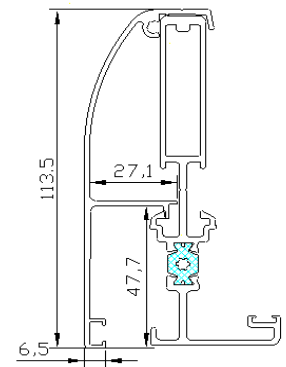

CHENEAU

Réf 674

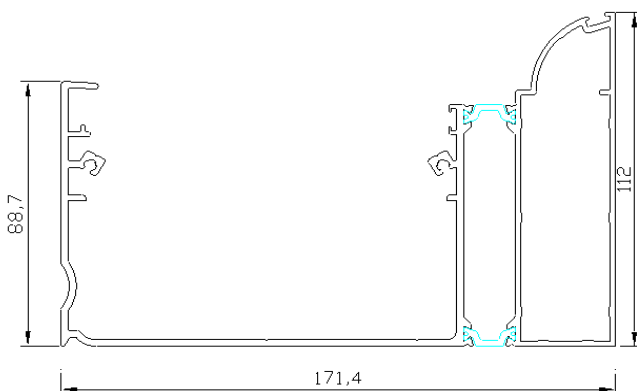

REHAUSSE

Réf 576

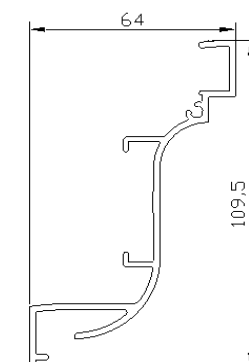

PORTE JOINT SABLIERE

Réf 578

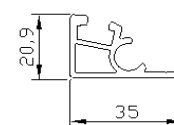

TRAVERSE

Réf 568

